

SDP8436

Silicon Phototransistor

FEATURES

- Side-looking plastic package
- 18° (nominal) acceptance angle
- Enhanced coupling distance
- Internal visible light rejection filter
- Low profile for design flexibility
- Wide sensitivity ranges
- Mechanically matched to SEP8736 infrared emitting diode

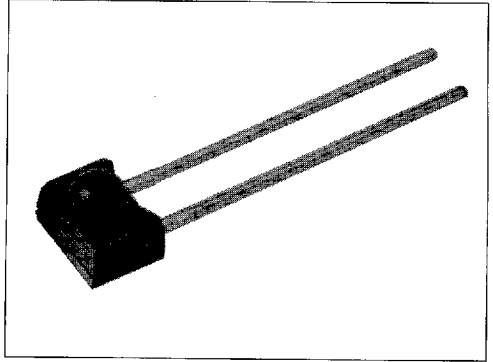

INFRA-82.TIF

DESCRIPTION

The SDP8436 is an NPN silicon phototransistor molded in a black plastic package which combines the mounting advantages of a side-looking package with the narrow acceptance angle and high optical gain of a T-1 package. The SDP8436 is designed for those applications which require longer coupling distances than standard side-looking devices can provide, such as touch screens. The device is also well suited to applications in which adjacent channel crosstalk could be a problem. The package is highly transmissive to the IR source energy while it provides effective shielding against visible ambient light.

OUTLINE DIMENSIONS in inches (mm)

Tolerance 3 plc decimals $\pm 0.005(0.12)$
2 plc decimals $\pm 0.020(0.51)$

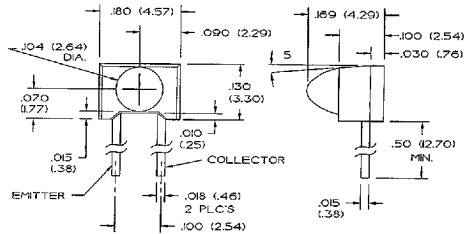

DIM_019.cdr

4551830 0022553 1T7

Honeywell

SDP8436

Silicon Phototransistor

ELECTRICAL CHARACTERISTIC (25°C unless otherwise noted)

PARAMETER	SYMBOL	MIN	TYP	MAX	UNITS	TEST CONDITIONS
Light Current	I_L				mA	$V_{CE}=5\text{ V}$ $H=1\text{ mW/cm}^2$ (1)
SDP8436-001		0.50				
SDP8436-002		4.00		10.0		
SDP8436-003		7.00		17.5		
SDP8436-004		12.5				
Collector Dark Current	I_{CEO}			100	nA	$V_{CE}=15\text{ V}$, $H=0$
Collector-Emitter Breakdown Voltage	$V_{(BR)CEO}$	30			V	$I_C=100\text{ }\mu\text{A}$
Emitter-Collector Breakdown Voltage	$V_{(BR)ECO}$	5.0			V	$I_E=100\text{ }\mu\text{A}$
Collector-Emitter Saturation Voltage	$V_{CE(SAT)}$			0.4	V	$I_C=0.1\text{ mA}$ $H=1\text{ mW/cm}^2$
Angular Response (2)	\emptyset		18		degr.	$I_F=\text{Constant}$
Rise And Fall Time	t_r, t_f		15		μs	$V_{CC}=5\text{ V}$, $I_L=1\text{ mA}$ $R_L=1000\text{ }\Omega$

Notes

1. The radiation source is an IRED with a peak wavelength of 890 nm.
2. Angular response is defined as the total included angle between the half sensitivity points.

ABSOLUTE MAXIMUM RATINGS

(25°C Free-Air Temperature unless otherwise noted)

Collector-Emitter Voltage	30 V
Emitter-Collector Voltage	5 V
Power Dissipation	100 mW (1)
Operating Temperature Range	-40°C to 85°C
Storage Temperature Range	-40°C to 85°C
Soldering Temperature (5 sec)	240°C

Notes

1. Derate linearly from 25°C free-air temperature at the rate of 0.78 mW/°C.

SCHEMATIC

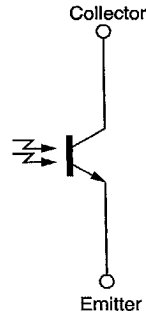

Honeywell reserves the right to make changes in order to improve design and supply the best products possible.

Honeywell

4551830 0022554 033

129

SDP8436

Silicon Phototransistor

SWITCHING TIME TEST CIRCUIT

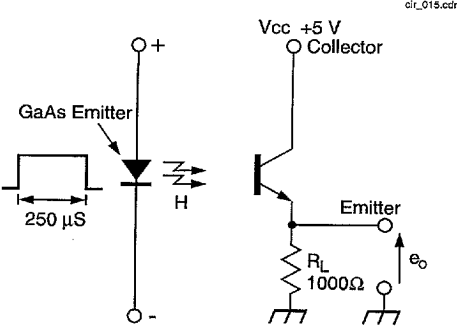

Fig. 1 Responsivity vs Angular Displacement

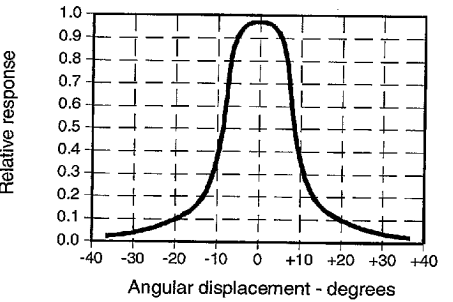
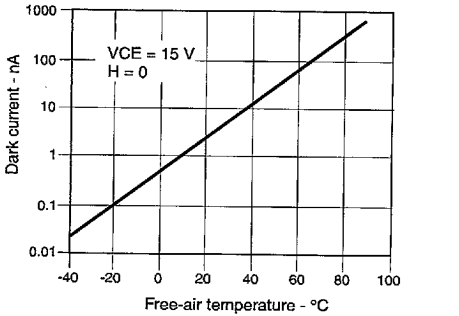

Fig. 3 Dark Current vs Temperature



SWITCHING WAVEFORM

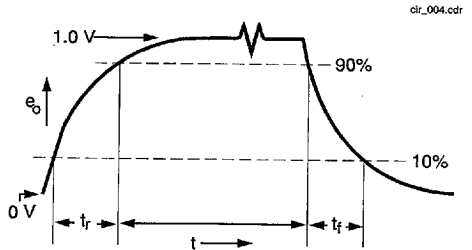

Fig. 2 Collector Current vs Ambient Temperature

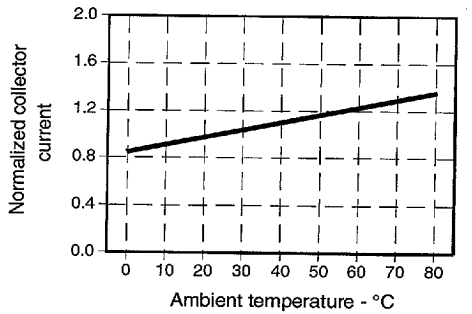
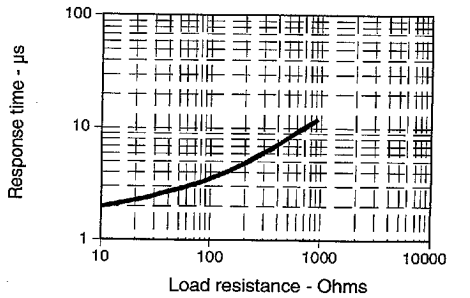

Fig. 4 Non-Saturated Switching Time vs Load Resistance



SDP8436

Silicon Phototransistor

Fig. 5 Spectral Responsivity

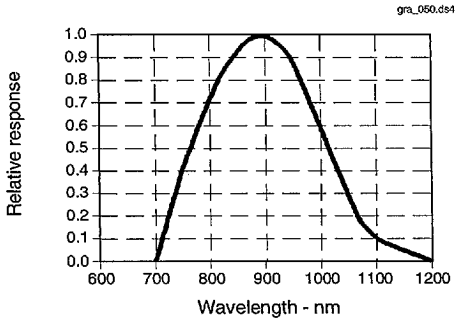
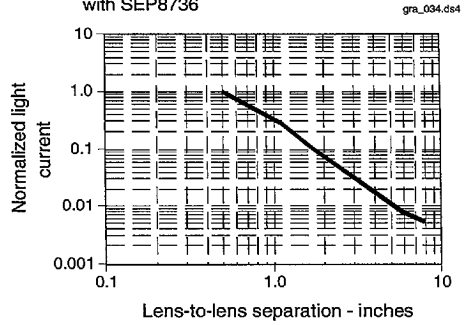

Fig. 6 Coupling Characteristics with SEP8736



All Performance Curves Show Typical Values

Honeywell reserves the right to make changes in order to improve design and supply the best products possible.

4551830 0022556 906
Honeywell